

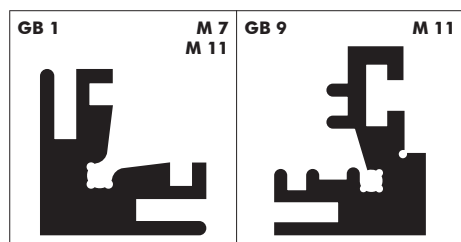

































## Profile overview

### Edge profiles















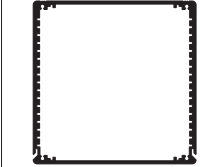

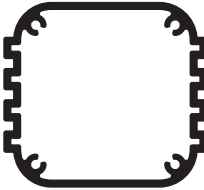
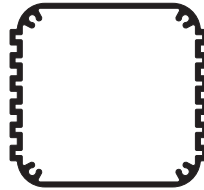
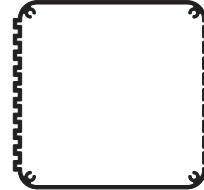
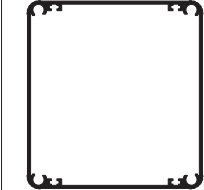
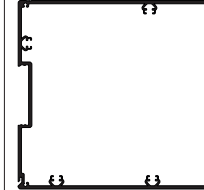



### Combination profiles







<p>KO H 0</p> <p>M 16 M 65</p> 	<p>KO H 1</p> <p>M 16 M 65</p> 	<p>KO H 2</p> <p>M 16 M 65</p> 	<p>KO H 4A</p> <p>M 16 M 65</p> 	<p>KO H 6</p> <p>M 17 M 65</p> 	<p>KO H 7</p> <p>M 17</p> 
<p>KO H 8</p> <p>M 17 M 65</p> 	<p>KO H 10</p> <p>M 17 M 65</p> 	<p>KO H 14</p> <p>M 17 M 65</p> 	<p>KO E 14</p> <p>M 18</p> 	<p>KO E 2</p> <p>M 16</p> 	<p>KO N 2</p> <p>M 16</p> 
<p>KO P 2</p> <p>M 17</p> 	<p>KO T 2</p> <p>M 16</p> 	<p>KO T 3</p> <p>M 16</p> 	<p>KO L 1</p> <p>M 18</p> 	<p>KO L 2</p> <p>M 18</p> 	<p>KO R 2</p> <p>M 16</p> 
<p>KO W 2</p> <p>M 18</p> 	<p>KO K 2</p> <p>M 16</p> 	<p>KO K 14</p> <p>M 18</p> 	<p>KO HL 0</p> <p>M 19</p> 	<p>KO HL 1</p> <p>M 19</p> 	<p>KO HL 2</p> <p>M 19</p> 
<p>KO HL 4</p> <p>M 19</p> 	<p>KO HL 6</p> <p>M 19</p> 	<p>KO HL 10</p> <p>M 19</p> 	<p>KO HL 14</p> <p>M 20</p> 	<p>KO G 5</p> <p>M 17</p> 	<p>KO F 3</p> <p>M 17</p> 
<p>KO TL 2</p> <p>M 20</p> 	<p>KO LL 2</p> <p>M 20</p> 	<p>KO RL 2</p> <p>M 20</p> 			

**Profile overview**



**Tube profiles**

TUG 03 M 27 	TUG 05 M 27 M 66 	TUG 07 M 27 	TUG 09 M 27 	TUG 17 M 28 M 66 	TUG V 09 M 29 
TUG V 17 M 29 	GP 222 M 24 	GP 211 M 24 	GP 223 M 24 	GB 305 M 22 	GB 50 M 23 
GP 213 M 25 M 62 	GP 214 M 26 M 62 	GP 215 M 26 M 62 	GP 216 M 26 M 62 	GP 217 M 62 M 25 	GP 218 M 62 M 25 M 63 
GP 219 M 62 M 25 	GP 220 M 62 M 26 	GP 221 M 25 	GB 87 M 61 M 30 	GB 88 M 61 M 30 	

**Profiles for cases with slide-in cover panel**

GB 81 M 8 	GB 82 M 8 	GB 83 M 9 	GB 84 M 9 	GB 307 M 8 	GB 308 M 9 
---	---	---	--	--	--

**Profiles for design case FRAME with integrated heatsink**

GB 89 M 63 M 47 	GB 90 M 63 M 47 	GB 91 M 63 M 47 
--	--	--

**Profile overview**

**Profiles for miniature aluminium casing**









GB 39 M 32 M 33 M 37	GB 46 M 32 M 33 M 37	GB 48 M 35 M 38 M 36	GB 49 M 35 M 38 M 36	GB 57 M 32	GB 58 M 32 M 37
GB 59 M 32 M 37	GB 60 M 32 M 37	GB 61 M 34	GB 62 M 33	GB 63 M 34 M 37	GB 64 M 33 M 37
GB 73 M 35 M 36	GB 74 M 33	GB 80 M 33	GB 85 M 39 M 40 M 41	GB 86 M 39 M 40	GB 92 M 33
GB 93 M 34	GB 94 M 43	GB 95 M 43	GB 96 M 44	GB 97 M 36	GB 98 M 36
GB 300 M 40 M 41	GB 301 M 40	GB 303 M 44			

**Side panel profiles**

GB 36 M 12	GB 38 M 12	GB 76 M 64 M 10	GB 77 M 64 M 10	GB 78 M 64 M 10	GB 79 M 64 M 10
G 118 M 52					

**Profile overview**







**Profiles for subracks**

GB 5  N 69	GB 20  N 69	GB 27  N 69	GB 29  N 17 N 69	GB 30  N 17 N 69	GB 33  N 69
GB 34  N 69	GB 35  N 17				



**Profiles for subracks**

GL 7  N 57 N 70
--

**Profiles for 19" plug-in boxes**

GB 18  N 6 N 66	GB 19  N 6 N 66	GB 21  N 66	GB 22  N 8 N 66	GB 23  N 8 N 66	GB 52  M 6
---	---	--	---	---	---

**Profiles for 19" plug-in boxes**

GB 28  N 67	GB 40  N 67	GB 54  N 67
--	--	--

**Profile overview**

**Profiles for mechanical engineering**

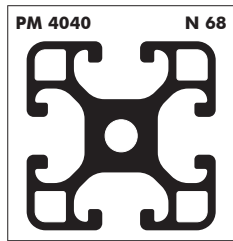

**Profiles for case with cooling fins**

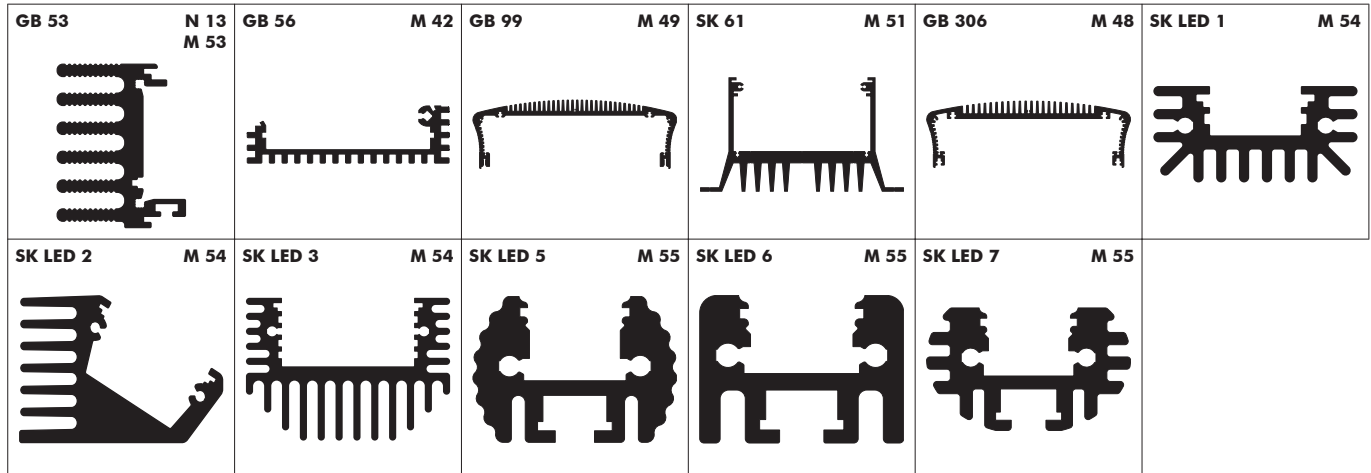

**Profiles for case with cooling fins**

