

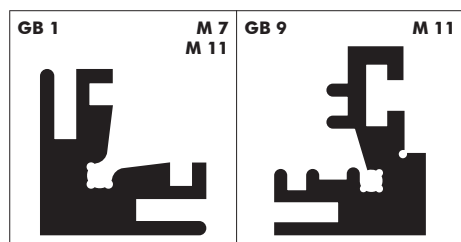

































Résumé des profils

Profils d'angle

























Profils combinés







<p>KO H 0</p> <p>M 16 M 65</p> 	<p>KO H 1</p> <p>M 16 M 65</p> 	<p>KO H 2</p> <p>M 16 M 65</p> 	<p>KO H 4A</p> <p>M 16 M 65</p> 	<p>KO H 6</p> <p>M 17 M 65</p> 	<p>KO H 7</p> <p>M 17</p> 
<p>KO H 8</p> <p>M 17 M 65</p> 	<p>KO H 10</p> <p>M 17 M 65</p> 	<p>KO H 14</p> <p>M 17 M 65</p> 	<p>KO E 14</p> <p>M 18</p> 	<p>KO E 2</p> <p>M 16</p> 	<p>KO N 2</p> <p>M 16</p> 
<p>KO P 2</p> <p>M 17</p> 	<p>KO T 2</p> <p>M 16</p> 	<p>KO T 3</p> <p>M 16</p> 	<p>KO L 1</p> <p>M 18</p> 	<p>KO L 2</p> <p>M 18</p> 	<p>KO R 2</p> <p>M 16</p> 
<p>KO W 2</p> <p>M 18</p> 	<p>KO K 2</p> <p>M 16</p> 	<p>KO K 14</p> <p>M 18</p> 	<p>KO HL 0</p> <p>M 19</p> 	<p>KO HL 1</p> <p>M 19</p> 	<p>KO HL 2</p> <p>M 19</p> 
<p>KO HL 4</p> <p>M 19</p> 	<p>KO HL 6</p> <p>M 19</p> 	<p>KO HL 10</p> <p>M 19</p> 	<p>KO HL 14</p> <p>M 20</p> 	<p>KO G 5</p> <p>M 17</p> 	<p>KO F 3</p> <p>M 17</p> 
<p>KO TL 2</p> <p>M 20</p> 	<p>KO LL 2</p> <p>M 20</p> 	<p>KO RL 2</p> <p>M 20</p> 			

Résumé des profilés



Profilés tubulaires

TUG 03 M 27 	TUG 05 M 27 M 66 	TUG 07 M 27 	TUG 09 M 27 	TUG 17 M 28 M 66 	TUG V 09 M 29 
TUG V 17 M 29 	GP 222 M 24 	GP 211 M 24 	GP 223 M 24 	GB 305 M 22 	GB 50 M 23 
GP 213 M 25 M 62 	GP 214 M 26 M 62 	GP 215 M 26 M 62 	GP 216 M 26 M 62 	GP 217 M 62 M 25 	GP 218 M 62 M 25 M 63 
GP 219 M 62 M 25 	GP 220 M 62 M 26 	GP 221 M 25 	GB 87 M 61 M 30 	GB 88 M 61 M 30 	

Boîtier avec couvercle enfichable



























GB 81 M 8 	GB 82 M 8 	GB 83 M 9 	GB 84 M 9 	GB 307 M 8 	GB 308 M 9 
---	---	---	--	--	--

Boîtier de design FRAME avec dissipateur intégré





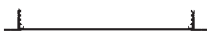

GB 89 M 63 M 47 	GB 90 M 63 M 47 	GB 91 M 63 M 47 
--	--	--

Résumé des profilés

Profilés pour petits boîtiers en aluminium









GB 39  M 32 M 33 M 37	GB 46  M 32 M 33 M 37	GB 48  M 35 M 38 M 36	GB 49  M 35 M 38 M 36	GB 57  M 32	GB 58  M 32 M 37
GB 59  M 32 M 37	GB 60  M 32 M 37	GB 61  M 34	GB 62  M 33	GB 63  M 34 M 37	GB 64  M 33 M 37
GB 73  M 35 M 36	GB 74  M 33	GB 80  M 33	GB 85  M 39 M 40 M 41	GB 86  M 39 M 40	GB 92  M 33
GB 93  M 34	GB 94  M 43	GB 95  M 43	GB 96  M 44	GB 97  M 36	GB 98  M 36
GB 300  M 40 M 41	GB 301  M 40	GB 303  M 44			

Profilés faces latérales

GB 36  M 12	GB 38  M 12	GB 76  M 64 M 10	GB 77  M 64 M 10	GB 78  M 64 M 10	GB 79  M 64 M 10
G 118  M 52					

Résumé des profilés







Profilés pour racks modulaires

GB 5  N 69	GB 20  N 69	GB 27  N 69	GB 29  N 17 N 69	GB 30  N 17 N 69	GB 33  N 69
GB 34  N 69	GB 35  N 17				



Profilés pour faces avant partielles

GL 7  N 57 N 70
--

Profilés pour boîtiers enfichables 19"

GB 18  N 6 N 66	GB 19  N 6 N 66	GB 21  N 66	GB 22  N 8 N 66	GB 23  N 8 N 66	GB 52  M 6
---	---	--	---	---	---

Profilés pour faces avant 19"

GB 28  N 67	GB 40  N 67	GB 54  N 67
--	--	--

Résumé des profilés

Profilés pour mechanical engineering

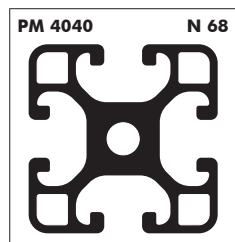

Profilés pour boîtiers à ailettes de dissipation

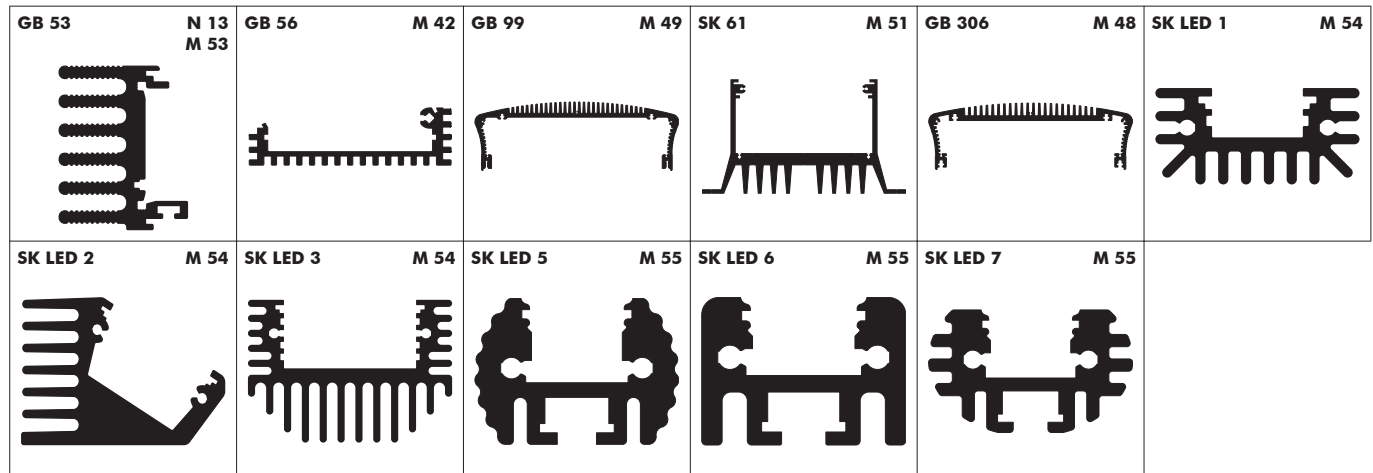

Profilés pour cassettes enfichables

