

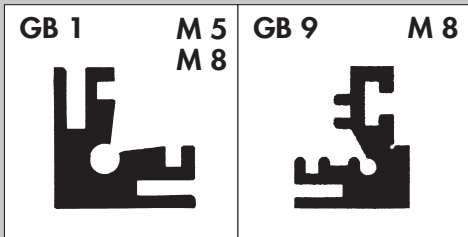









































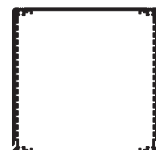
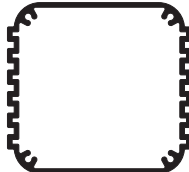
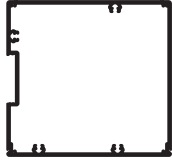

Edge profiles





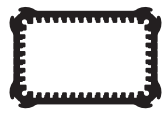
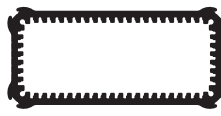

Combination profiles

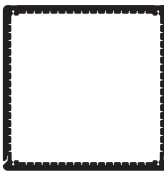
KO H 0 M 13 M 46 	KO H 1 M 13 M 46 	KO H 2 M 13 M 46 	KO H 4A M 13 M 46 	KO H 6 M 14 M 46 	KO H 7 M 14 
KO H 8 M 14 M 46 	KO H 10 M 14 M 46 	KO H 14 M 14 M 46 	KO P 2 M 13 	KO E 14 M 14 	KO E 2 M 13 
KO T 2 M 13 	KO N 2 M 13 	KO K 14 M 15 	KO L 1 M 15 	KO L 2 M 15 	KO W 2 M 15 
KO K 2 M 13 	KO HL 0 M 16 	KO HL 1 M 16 	KO HL 2 M 16 	KO HL 4 M 16 	KO HL 6 M 16 
KO HL 10 M 16 	KO HL 14 M 17 	KO LL 2 M 17 	KO TL 2 M 17 	KO R 2 M 13 	KO G 5 M 14 
KO F 3 M 14 					



## Tube profiles

TUG 03 M 23 	TUG 05 M 23 M 47 	TUG 09 M 23 	TUG 17 M 23 M 47 	GP 211 M 20 	GB 50 M 19 
GP 213 M 21 M 43 	GP 217 M 21 M 43 	GP 214 M 21 M 43 	GP 216 M 22 M 43 	GP 215 M 22 M 43 	GP 218 M 21 M 43 
GP 219 M 21 M 43 	GP 220 M 21 M 43 	GB 87 M 25 M 42 	GB 88 M 25 M 42 	TUG V 09 M 24 	TUG V 17 M 24 







## Profiles for cases with slide-in cover panel

GB 81 M 6 	GB 82 M 6 	GB 83 M 6 	GB 84 M 6 
--	--	--	---











## Profiles for design case „Frame“ with integrated heatsink

GB 89 M 44 	GB 90 M 44 	GB 91 M 44 
---	---	---



### Side panel profiles

GB 36 M 9 	GB 38 M 9 	GB 76 M 7 M 45 	GB 77 M 7 M 45 	GB 78 M 7 M 45 	GB 79 M 7 M 45 
G 118 M 35 					







### Profiles for subracks

GB 29 N 15 N 30 N 74 	GB 30 N 15 N 30 N 74 	GB 31 N 74 	GB 32 N 74 	GB 33 N 74 	GB 34 N 74 
GB 5 N 74 	GB 20 N 74 	GB 27 N 75 	GB 35 N 15 N 73 	GB 37 N 75 	





### Profiles for part front panels

GL 7 N 60 N 76 	GB 14 N 76 
--	---

### Profiles for 19" plug-in boxes

GB 18 N 6 N 71 	GB 19 N 6 N 71 	GB 21 N 71 	GB 22 N 8 N 71 	GB 23 N 8 N 10 N 71 	GB 52 M 4 
--	--	---	--	--	--





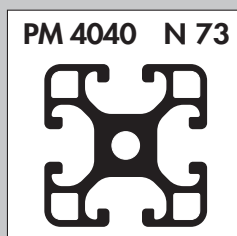

**Profiles for 19" front panels**

<p>GB 28 N 7 N 10 N 72</p> 	<p>GB 40 N 7 N 72</p> 	<p>GB 41 N 7 N 72</p> 	<p>GB 54 N 7 N 72</p> 	<p>GB 55 N 7 N 72</p> 
--	---	---	---	---





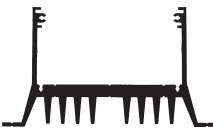
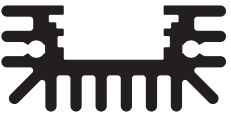









**Profiles for mechanical engineering**



**Profiles for case with cooling fins**

<p>GB 56 M 32</p> 	<p>KRH 6 M 36</p> 	<p>KOS 5 M 36</p> 	<p>GB 53 M 37 N 73</p> 	<p>SK 61 M 34</p> 
<p>SK LED 1 M 38</p> 	<p>SK LED 2 M 38</p> 	<p>SK LED 3 M 38</p> 		

**Profiles for insert modules**

<p>GP 190 N 39 N 77</p> 	<p>GP 191 N 36 N 77</p> 	<p>GP 192 N 36 N 37 N 77</p> 	<p>GP 193 N 37 N 38 N 77</p> 	<p>GP 195 N 41 N 42 N 80</p> 	<p>GP 196 N 41 N 80</p> 
<p>GP 197 N 42 N 43 N 80</p> 	<p>GP 199 N 48 N 76</p> 	<p>GP 200 N 38 N 78</p> 	<p>GP 201 N 38 N 78</p> 	<p>GP 202 N 38 N 78</p> 	<p>GP 206 N 40 N 79</p> 
<p>GP 207 N 40 N 79</p> 	<p>GP 208 N 40 N 79</p> 	<p>GP 209 N 40 N 79</p> 